

3a

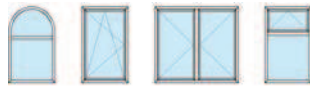

doorsneden ■ coupes ■ sections

Apollo cold PC1

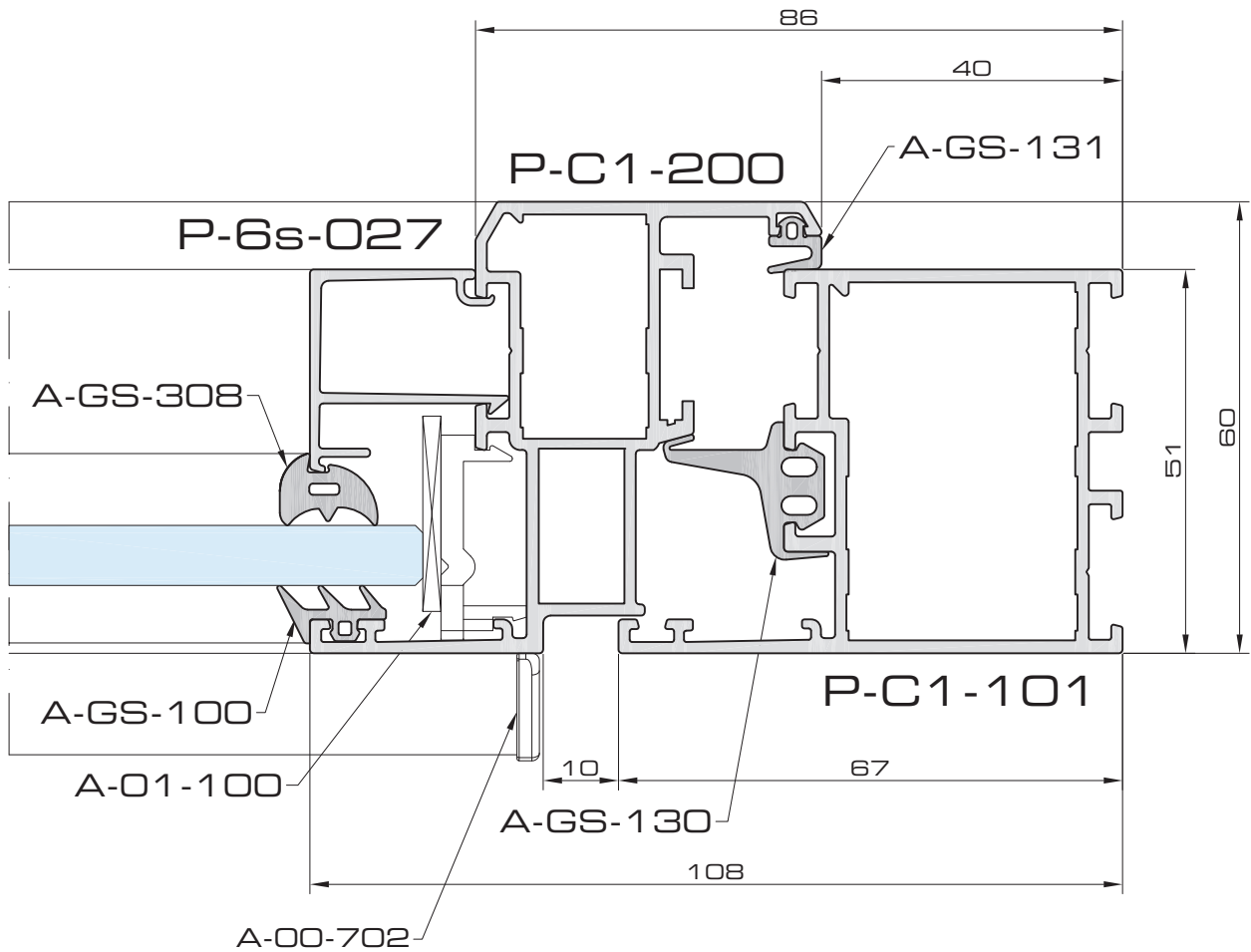
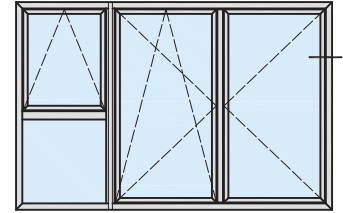

door3

7a

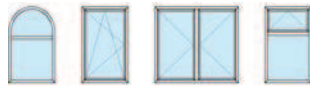

doorsneden ■ coupes ■ sections

Apollo cold PC1

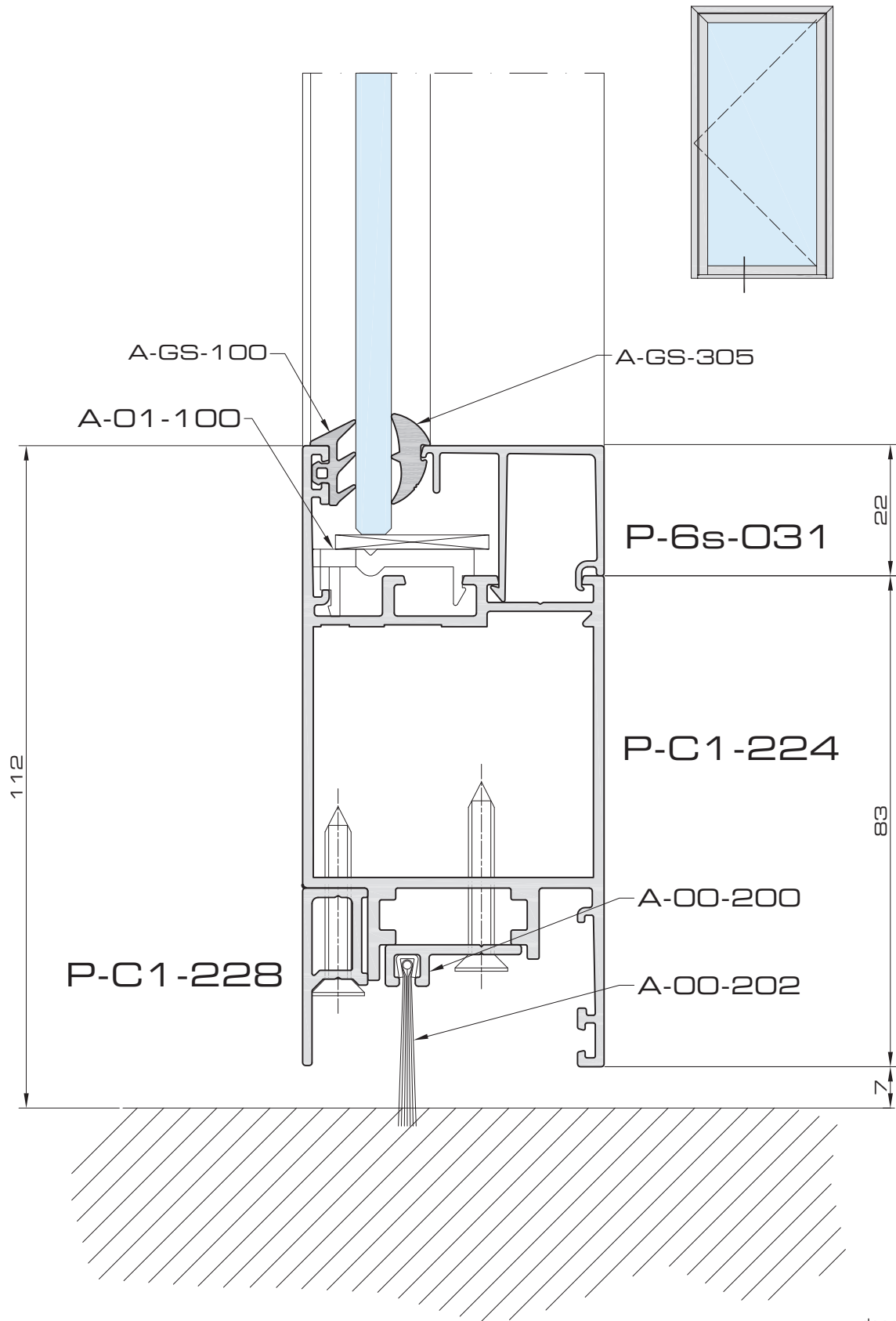

door7

8a

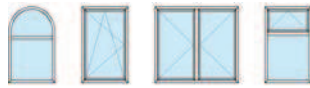

doorsneden ■ coupes ■ sections

Apollo cold PC1

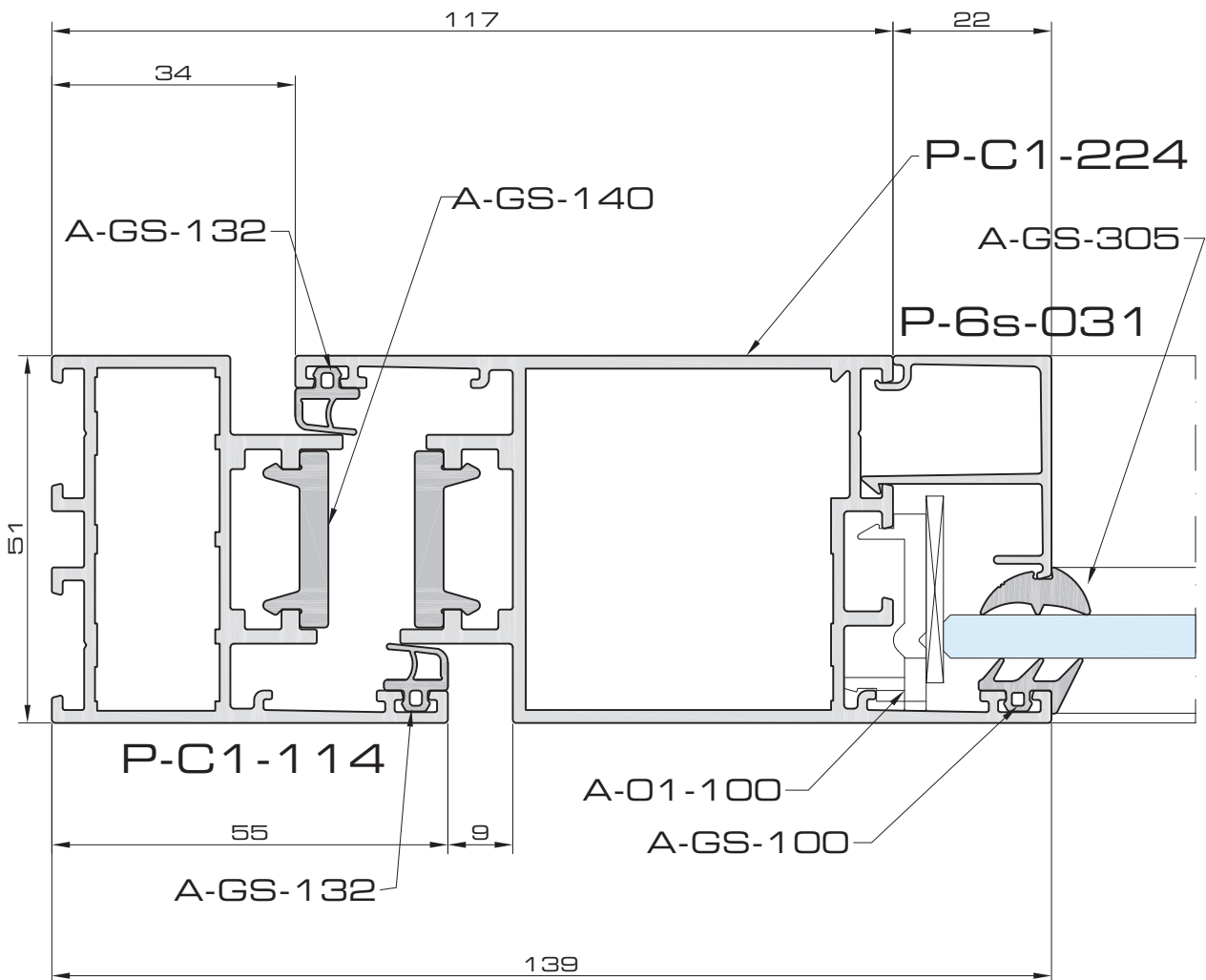
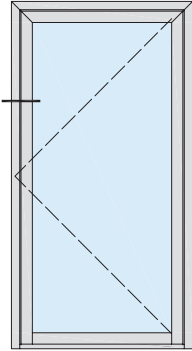

doorB

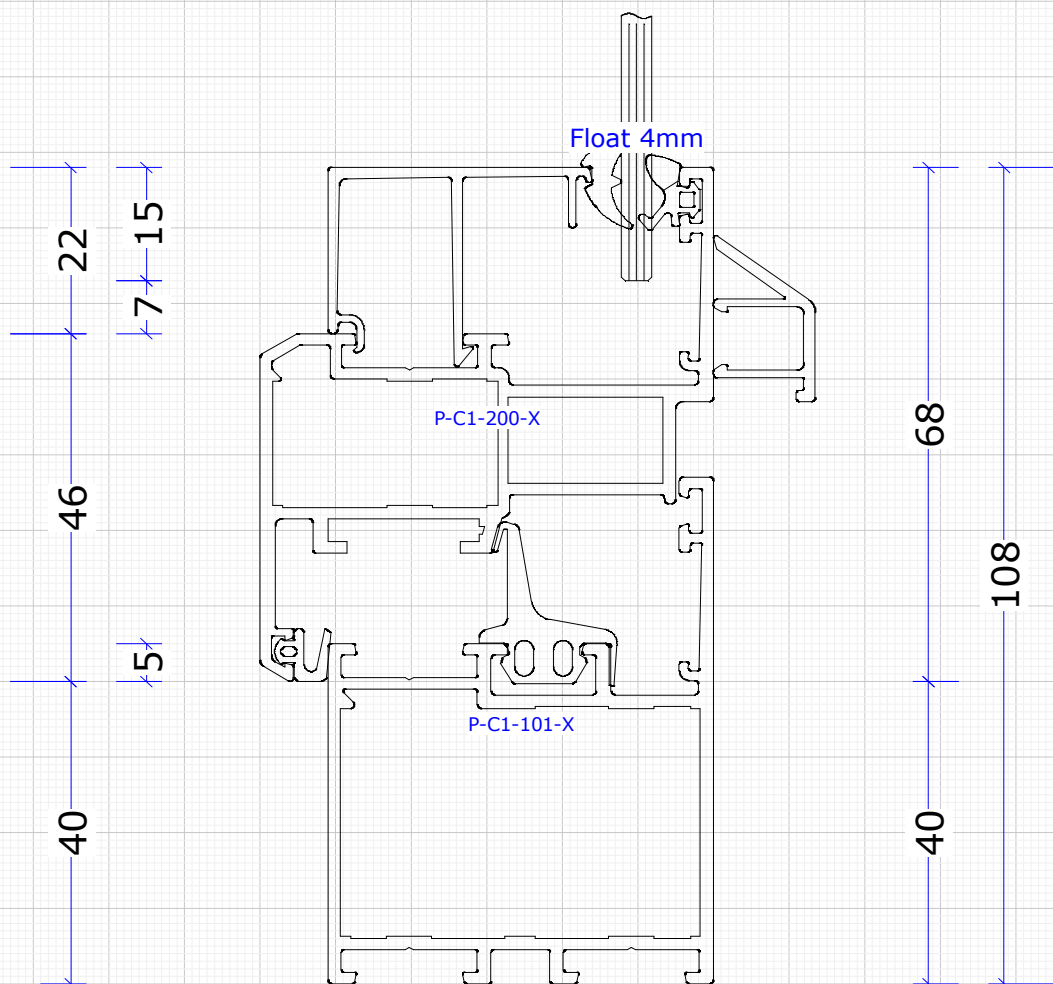

Firma PLASTIXAL Kołakowski Mariusz

System: Apollo Cold P-C1 - System "zimny", profil 51 mm	Skala: 1:1	Data: 2014-04-03
Nazwa rysunku: Muster "ciepły"		Strona: 2

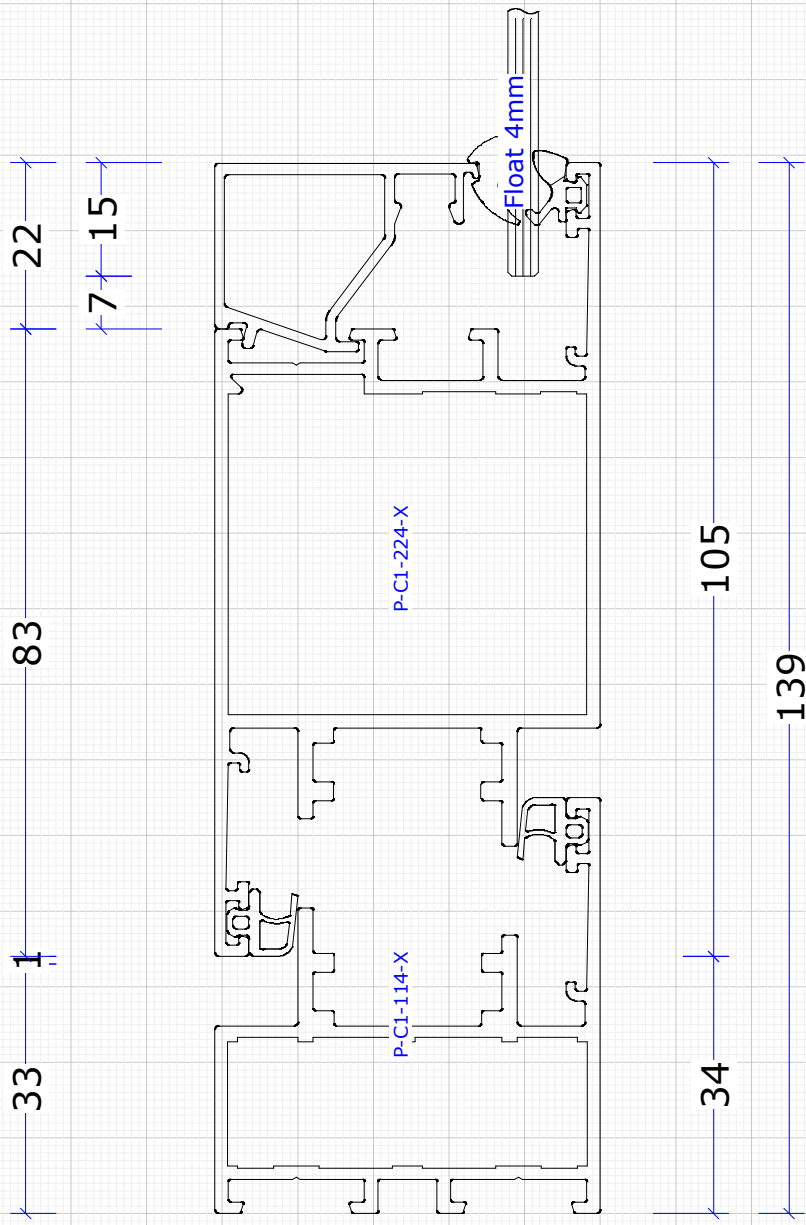

Firma PLASTIXAL Kołakowski Mariusz

System:

Apollo Cold P-C1 - System "zimny", profil 51 mm

Skala:

1:1

Data:

2014-04-03

Nazwa rysunku:

Muster "ciepły"

Strona:

3