

# 2a

doorsneden ■ coupes ■ sections

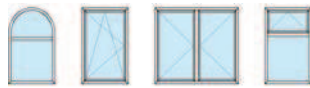

## HerCules P02

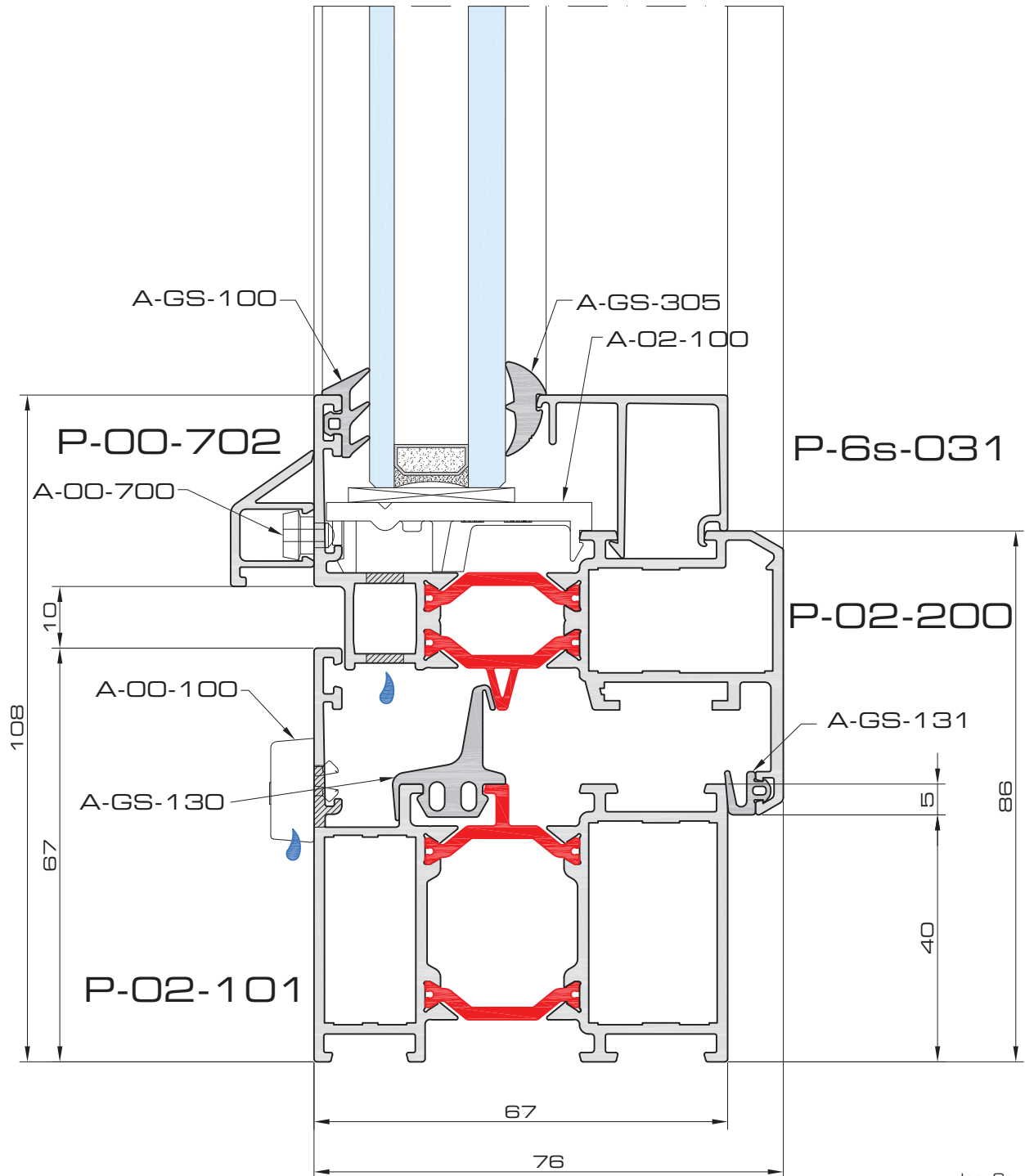
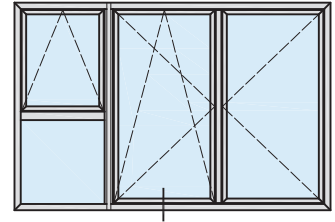

door2a



**Variant!**  
Planea

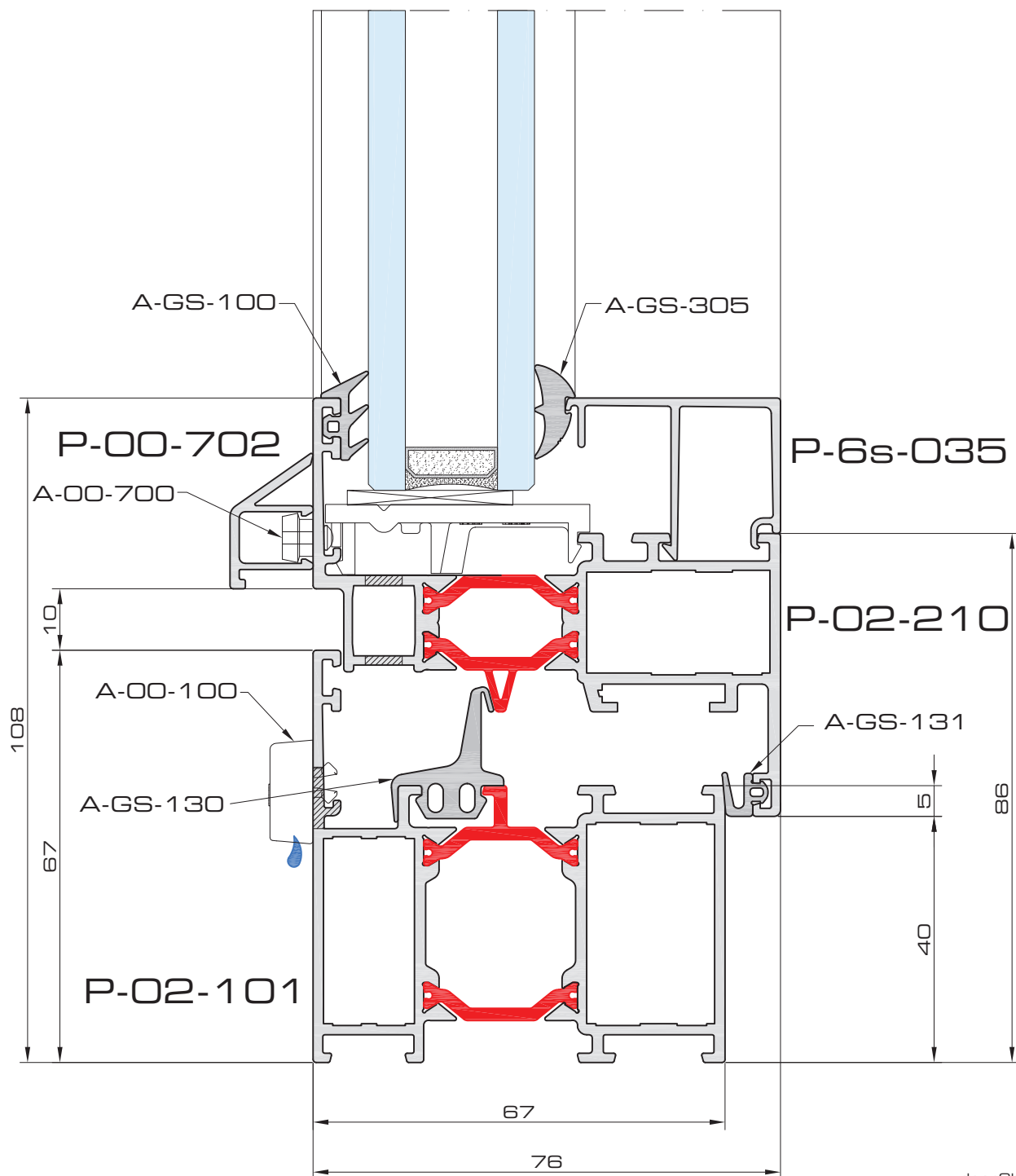
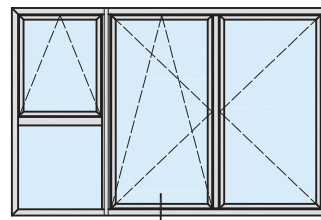

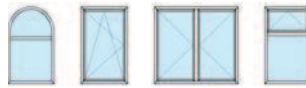

**Variant!**  
PVC-nut

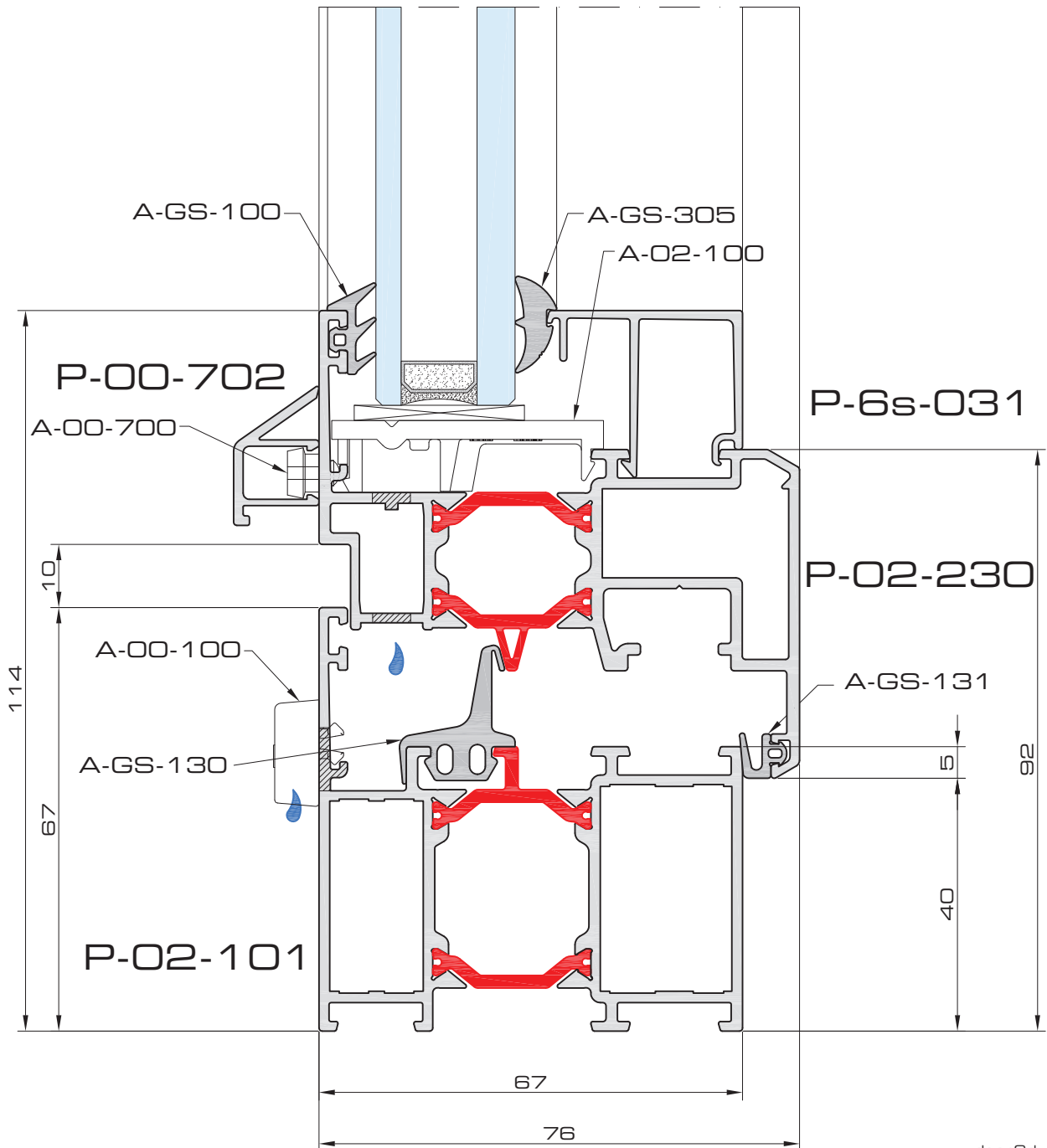
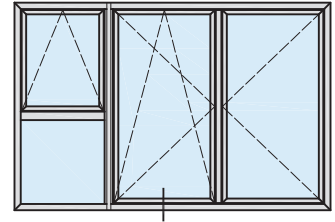

7e

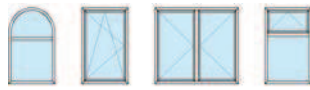

# HerCules P02

doorsneden ■ coupes ■ sections

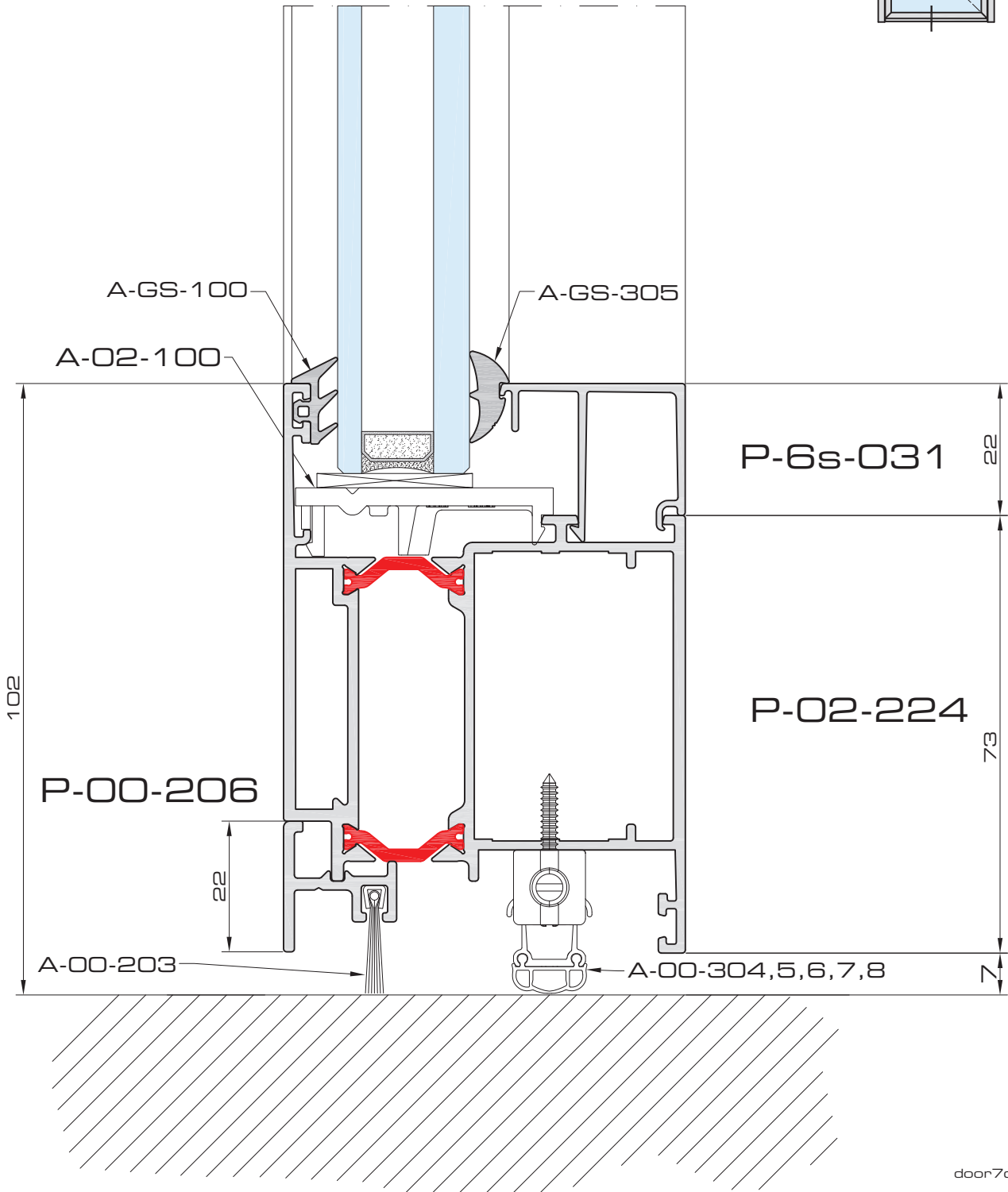
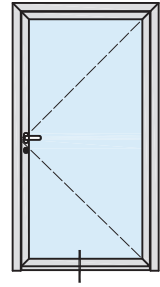

door7c

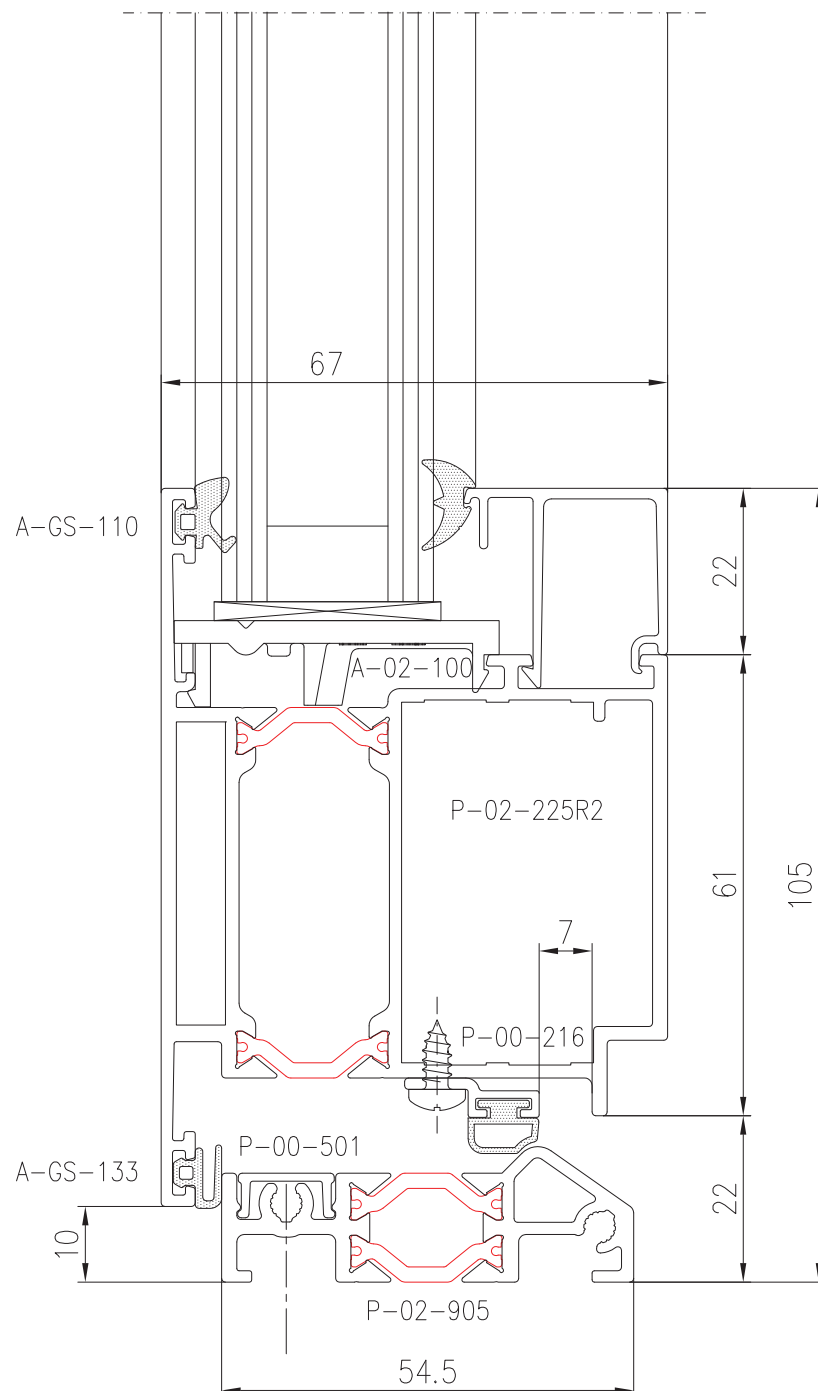
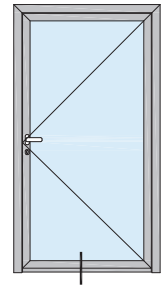

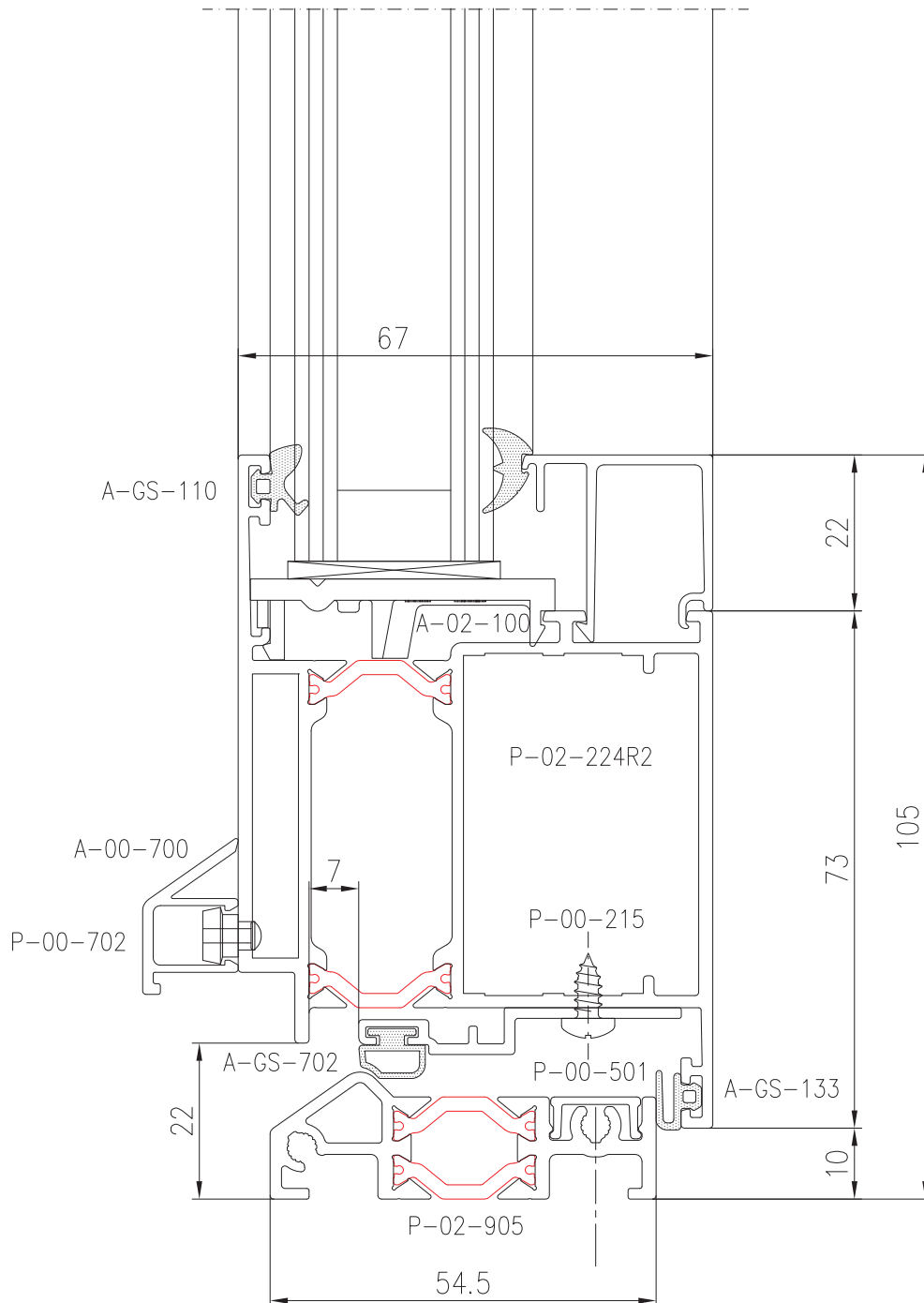
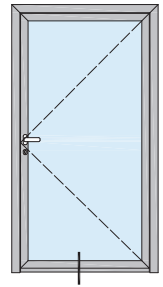

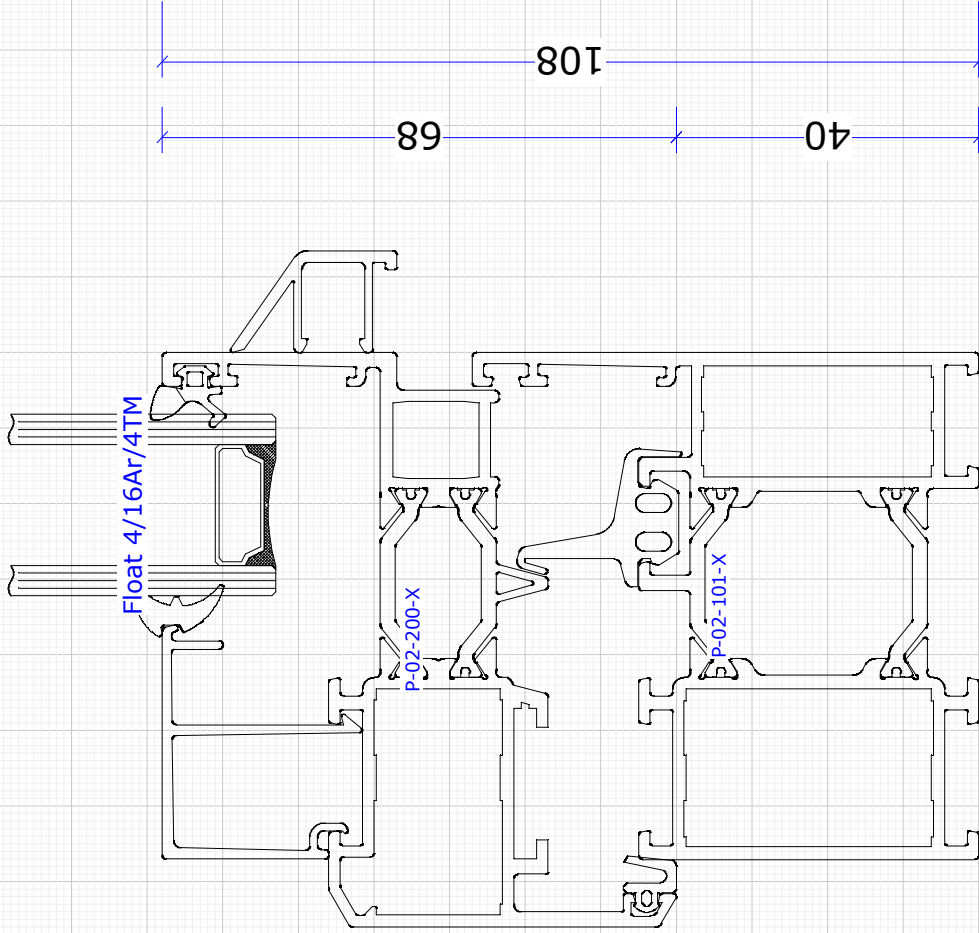

Firma PLASTIXAL Kołakowski Mariusz

System:	Skala:	Data:
<b>Hercules P-02 - System "ciepły", profil 67 mm</b>	<b>1:1</b>	<b>2014-04-03</b>
Nazwa rysunku:		Strona:
<b>Muster "ciepły"</b>		<b>8</b>

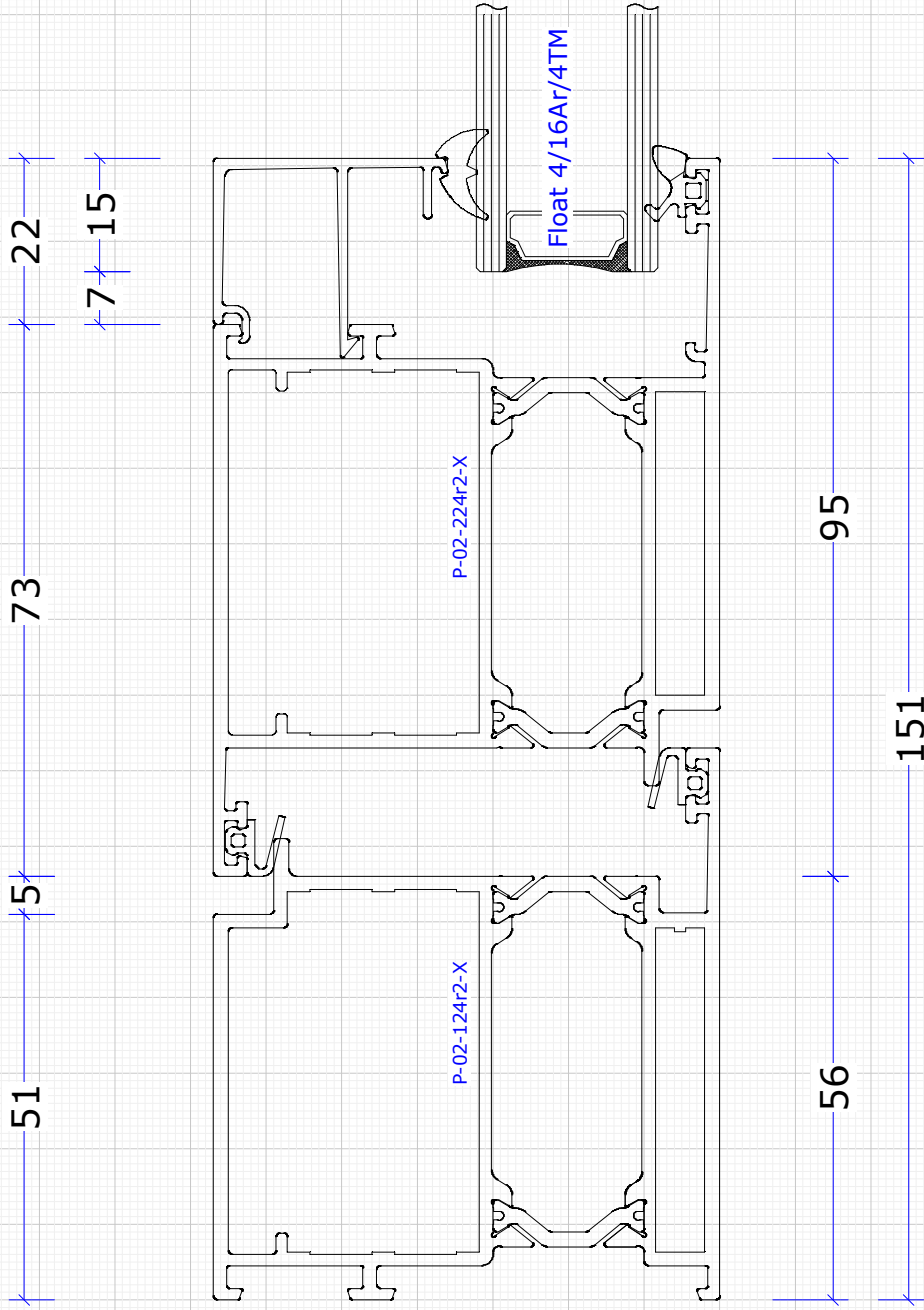

Firma PLASTIXAL Kołakowski Mariusz

System:

Hercules P-02 - System "ciepły", profil 67 mm

Skala:

1:1

Data:

2014-04-03

Nazwa rysunku:

Muster "ciepły"

Strona:

9